

# Kantprofil 1.2.2 A

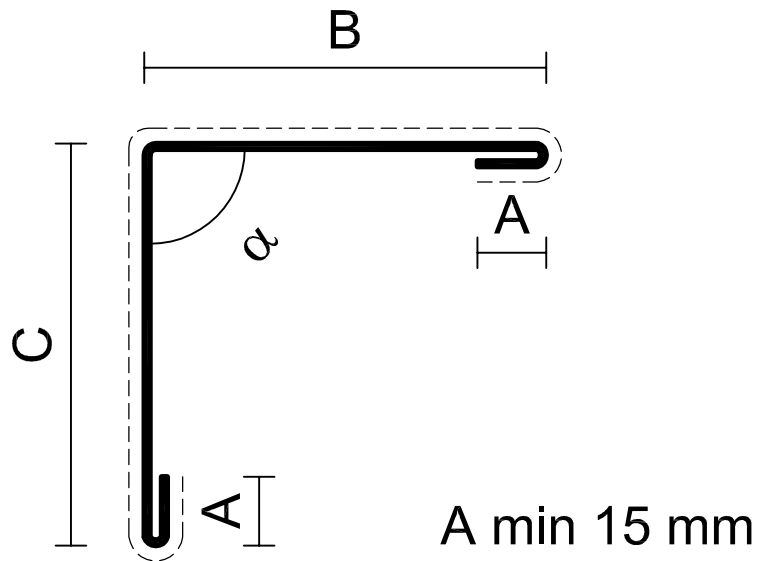

$2 \times A + B + C$	Einzellängen bis 6000 mm	5 Kantungen
----------------------	--------------------------	-------------

----- Beschichtungsseite

<b>LAUKIEN</b> -Anwendungstechnik- Borsigstraße 23 24145 Kiel Tel. (0431) 7187-0 Fax (0431) 7187-138				Oberfläche		Maßstab 1:1		Position	
				Datum		Name		Ausseneckprofil 1.2.2 A	
Bearb.		11-2012		JSC					
Gepr.									
								Blatt	
								Bl	
Zust.	Änderung	Datum	Name	Dateiname					

# Kantprofil 1.2.2 B

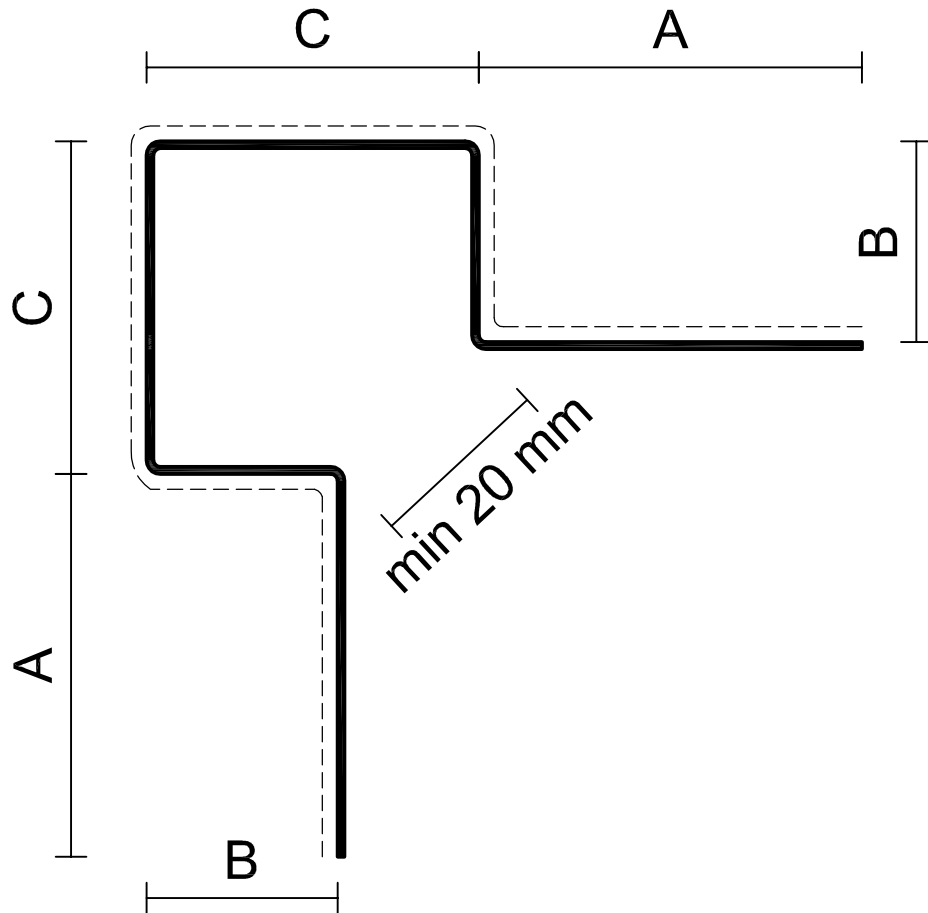

$2 \times A + 2 \times B + 2 \times C$

Einzellängen bis 6000 mm

5 Kantungen

----- Beschichtungsseite

**LAUKIEN**

-Anwendungstechnik-

Borsigstraße 23  
24145 Kiel  
Tel. (0431) 7187-0  
Fax (0431) 7187-138

Oberfläche

Maßstab 1:1

Position

Datum

Name

Bearb. 11-2012

JSC

Gepr.

Ausseneckprofil  
1.2.2 B

Blatt

Bl

Zust.	Änderung	Datum	Name	Dateiname

# Kantprofil 1.2.2 C

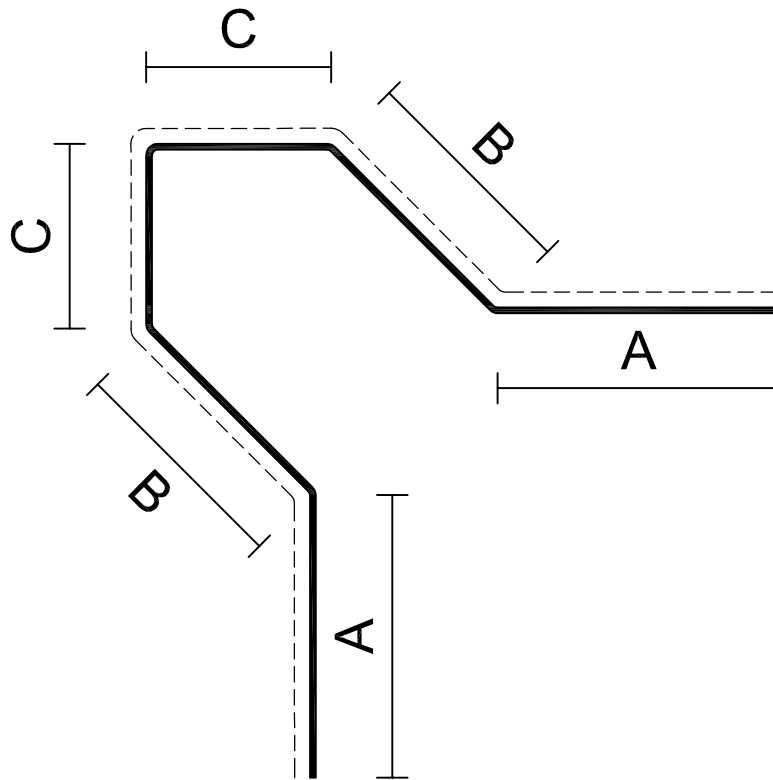

$2 \times A + 2 \times B + 2 \times C$

Einzellängen bis 6000 mm

5 Kantungen

----- Beschichtungsseite

 -Anwendungstechnik- Borsigstraße 23 24145 Kiel Tel. (0431) 7187-0 Fax (0431) 7187-138		Oberfläche		Maßstab 1:1	Position											
		<table border="1"> <tr> <td></td> <td>Datum</td> <td>Name</td> </tr> <tr> <td>Bearb.</td> <td>11-2012</td> <td>JSC</td> </tr> <tr> <td>Gepr.</td> <td></td> <td></td> </tr> <tr> <td></td> <td></td> <td></td> </tr> </table>			Datum	Name	Bearb.	11-2012	JSC	Gepr.						Ausseneckprofil 1.2.2 C
	Datum	Name														
Bearb.	11-2012	JSC														
Gepr.																
				Blatt												
				Bl												
Zust.	Änderung	Datum	Name	Dateiname												

# Kantprofil 1.2.2 D

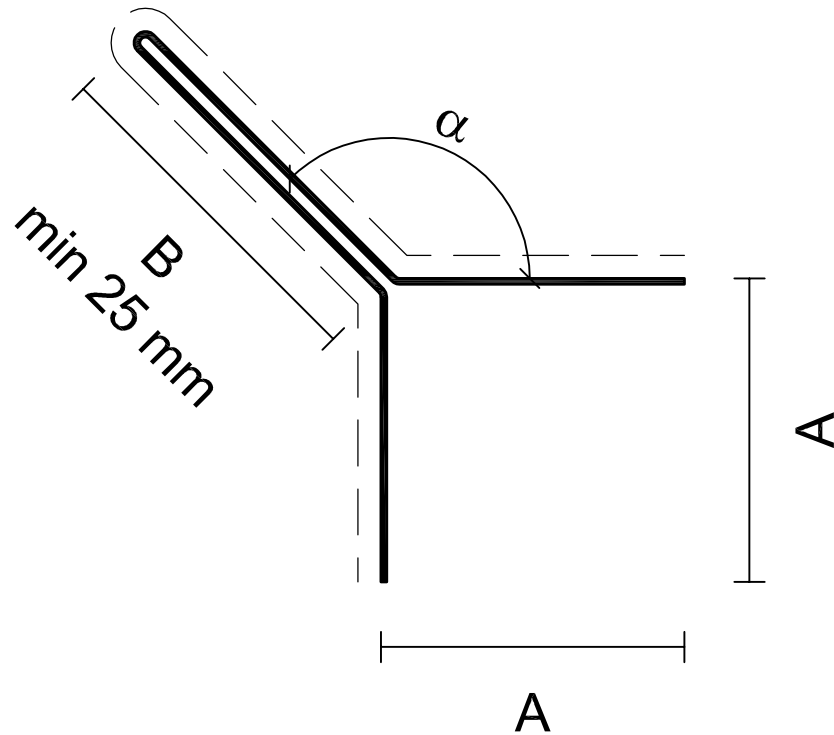

2 x A + 2 x B	Einzellängen bis 6000 mm	4 Kantungen
---------------	--------------------------	-------------

----- Beschichtungsseite

<b>LAUKIEN</b> -Anwendungstechnik- Borsigstraße 23 24145 Kiel Tel. (0431) 7187-0 Fax (0431) 7187-138				Oberfläche		Maßstab 1:1	Position
				Datum		Name	
Bearb.	11-2012	JSC					
Gepr.							
Zust.	Änderung	Datum	Name	Dateiname			Blatt
							Bl

# Kantprofil 1.2.2 E

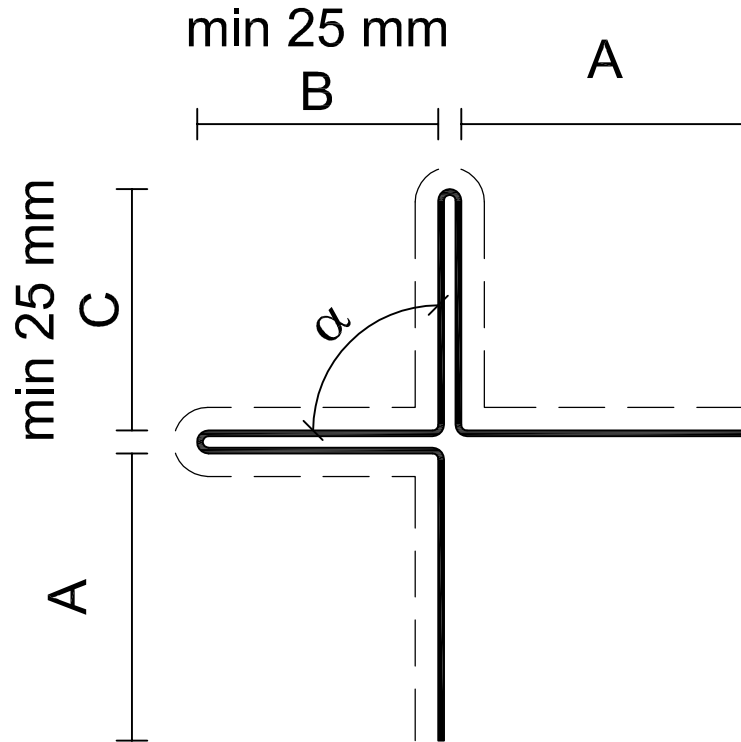

$2 \times A + 2 \times B + 2 \times C$	Einzellängen bis 6000 mm	7 Kantungen
--	--------------------------	-------------

----- Beschichtungsseite

<b>LAUKIEN</b> -Anwendungstechnik- Borsigstraße 23 24145 Kiel Tel. (0431) 7187-0 Fax (0431) 7187-138		Oberfläche		Maßstab 1:1	Position											
		<table border="1"> <tr> <td></td> <td>Datum</td> <td>Name</td> </tr> <tr> <td>Bearb.</td> <td>11-2012</td> <td>JSC</td> </tr> <tr> <td>Gepr.</td> <td></td> <td></td> </tr> <tr> <td></td> <td></td> <td></td> </tr> </table>			Datum	Name	Bearb.	11-2012	JSC	Gepr.						Ausseneckprofil 1.2.2 E
	Datum	Name														
Bearb.	11-2012	JSC														
Gepr.																
				Blatt												
				Bl												
Zust.	Änderung	Datum	Name	Dateiname												

# Kantprofil 1.2.2 F

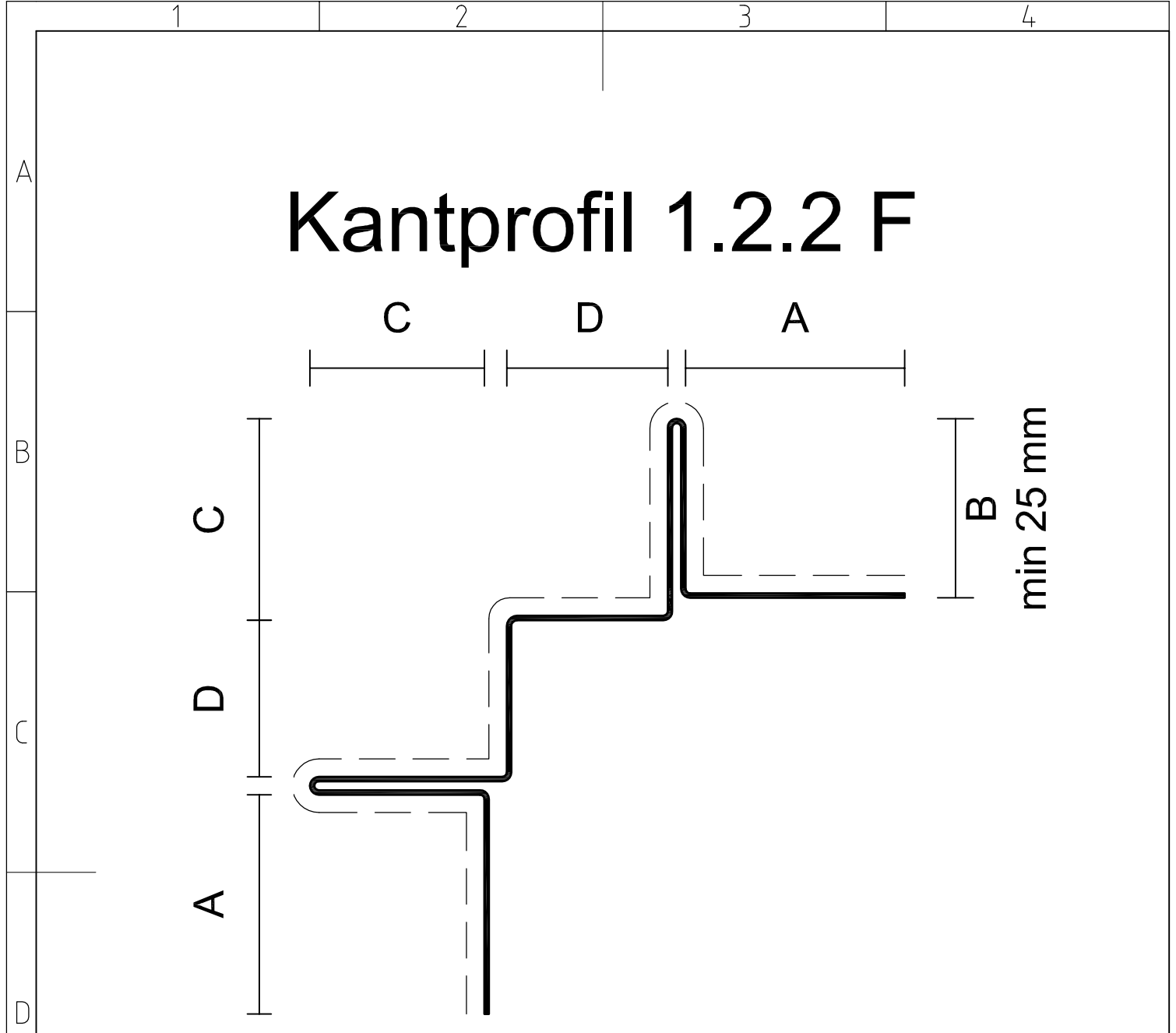

$2 \times A + 2 \times B + 2 \times C + 2 \times D$	Einzellängen bis 6000 mm	9 Kantungen
---	--------------------------	-------------

----- Beschichtungsseite

<b>LAUKIEN</b> -Anwendungstechnik- Borsigstraße 23 24145 Kiel Tel. (0431) 7187-0 Fax (0431) 7187-138	Oberfläche		Maßstab 1:1	Position		
	Datum		Ausseneckprofil 1.2.2 F			
	Bearb.	11-2012			Name	JSC
	Gepr.					
Zust.		Änderung	Datum	Name	Dateiname	Blatt
						Bl

# Kantprofil 1.2.2 G

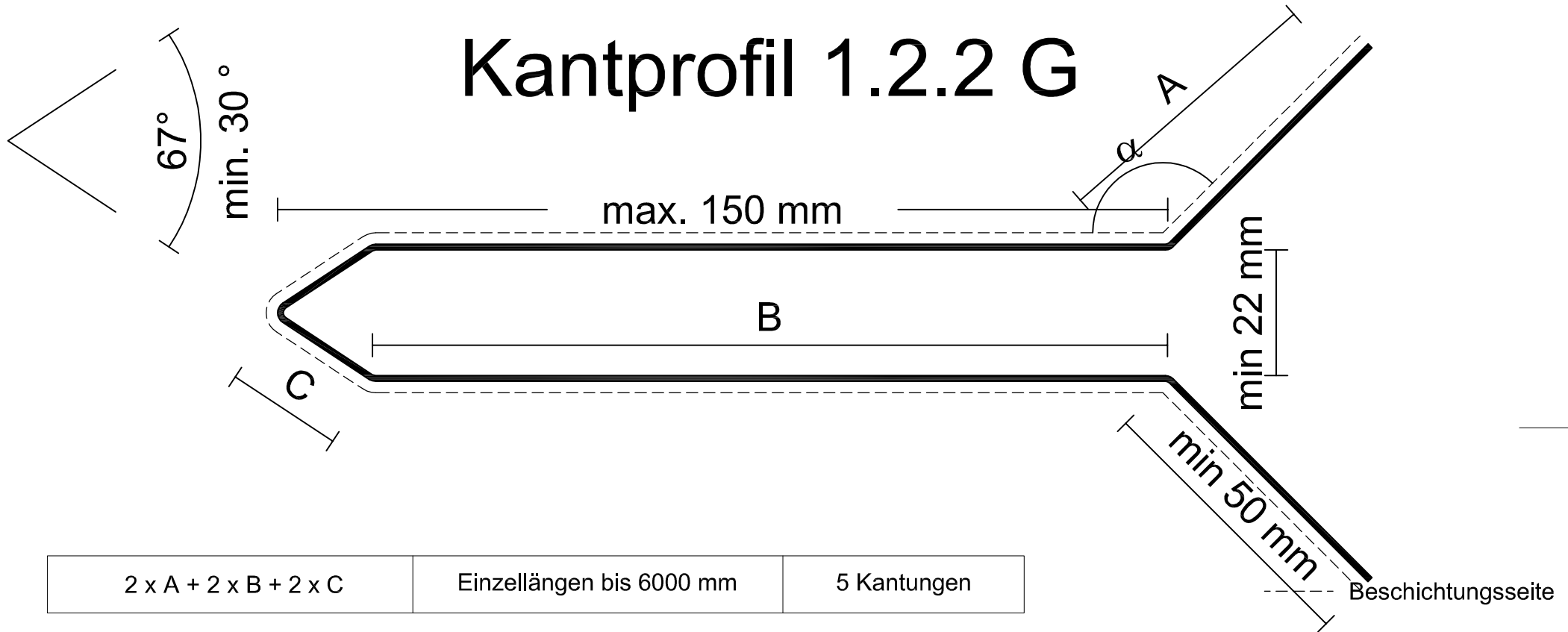

2 x A + 2 x B + 2 x C	Einzellängen bis 6000 mm	5 Kantungen
-----------------------	--------------------------	-------------

<b>LAUKIEN</b> -Anwendungstechnik- Borsigstraße 23 24145 Kiel Tel. (0431) 7187-0 Fax (0431) 7187-138	Oberfläche		Maßstab 1:1	Position
	Bearb.	Datum	Ausseneckprofil 1.2.2 G	
	Gepr.	Name		
	Zust.		Änderung	Datum
			Dateiname	Blatt
				Bl

# Kantprofil 1.2.2 H

max. 150 mm

min 25 mm

A

B

B

D

D

min 22 mm

A  
C  
min 25 mm

max 150 mm

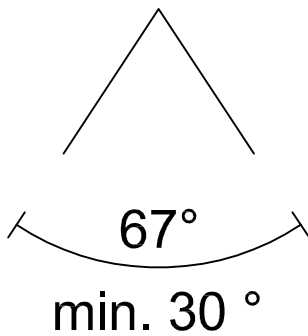

$2 \times A + 4 \times B + 4 \times C$

Einzellängen bis 6000 mm

9 Kantungen

----- Beschichtungsseite

**LAUKIEN**

-Anwendungstechnik-

Borsigstraße 23  
24145 Kiel  
Tel. (0431) 7187-0  
Fax (0431) 7187-138

Oberfläche

Maßstab 1:1

Position

Datum

Name

Bearb. 11-2012

JSC

Gepr.

Ausseneckprofil  
1.2.2 H

Blatt

Bl

Zust.	Änderung	Datum	Name	Dateiname